

Contents

Setup

Use

Troubleshooting

Status LED

Appendix



Owner's Manual

HEOS Link

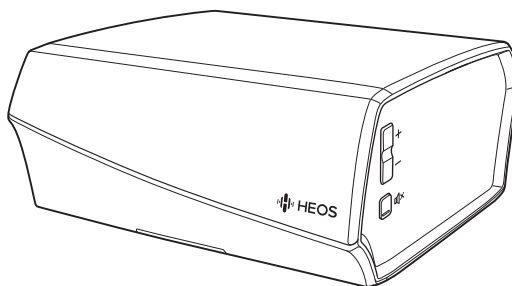

INTRODUCTION	4	HEOS account	24
BEFORE YOU BEGIN	5	What is a HEOS account?	24
System Requirements	5	Why do I need a HEOS account?	24
Network Requirements	5	Signing up for a HEOS account	24
Controller Requirements	6	Changing Your HEOS account	24
Getting To Know Your HEOS Link	7	Playing from Streaming Music Services	25
Front panel	8	Adding a Music Service	25
Controls	9	Changing Music Service Settings	25
Back panel	10	Listening To The Same Music In Multiple Rooms	26
Placing Your HEOS Link	12	Grouping Rooms	26
Connecting External Devices	13	Ungrouping Rooms	27
Connecting to an Amplifier or AV Receiver	13	Grouping All Rooms (Party Mode)	28
Connecting to a Subwoofer	13	Ungrouping All Rooms	29
Connecting an Audio Playback Device	14	Using the Now Playing Queue	30
Connecting a USB storage device	14	Play Now	30
Powering Your HEOS Link	15	Play Now & Replace Queue	30
Getting the HEOS App	15	Play Next	30
SETTING UP YOUR FIRST HEOS LINK	16	Add to End of Queue	30
ADDING MORE HEOS DEVICES	17	Repeat and Shuffle Playback	30
Adding Wired HEOS Devices	17	Rearranging the Now Playing Queue	31
Adding Wireless HEOS Devices	17	Deleting Songs from the Play Queue	31
USING YOUR HEOS LINK	18	Deleting All Songs from the Play Queue	32
Selecting a Room	18	Saving Playlists	32
Listening to Radio	19		
Playing music stored on your mobile device	19		
Playing music from your networked PC or NAS	20		
Playing music from an external audio device	21		
Streaming an external audio device to any HEOS device	22		
Playing music from a USB device	23		



MAKING ADJUSTMENTS	33	BASIC TROUBLESHOOTING	42
Changing the Name of a HEOS Link	33	My HEOS Device won't connect to my network using the audio cable	42
Changing the Wireless Network Connection	33	I get a message "Device was not found"	42
Adjusting the Equalizer	34	I can't control an external device via IR and Trigger	43
Adjusting the Audio Quality	34	I don't hear anything from the Link	43
Adjusting the Volume Control Method	34	Music cuts out or delays sometimes	44
Adjusting the Status Light Brightness	34	I hear a delay when using the AUX Input with my TV	44
Advanced Settings	35	Connecting to a WPS Network	44
Network Settings	35	Resetting Your HEOS Device	45
Firmware Upgrade	35	Restoring the HEOS Device to Factory Defaults	45
About	36	Contact Denon	46
External Device Control	37	Status LED Table	47
IR Control	37	Supported File Types and Codecs	53
Trigger Control	38	SPECIFICATIONS	54
UPDATING YOUR SYSTEM	39	INFORMATION	56
ADVANCED FEATURES	40	Trademarks	56
Submit Diagnostics	40	License	57
Sharing Music from your Mobile Device	41	License Information for the Software Used in the Unit	57
Resetting Your Controller App	41		
Power Modes	41		
Network Standby	41		
Deep Standby	41		
Off	41		



Thank you for purchasing this HEOS product. To ensure proper operation, please read this owner's manual carefully before using the product.

NOTE

THIS DOCUMENT CONTAINS INFORMATION THAT IS SUBJECT TO CHANGE WITHOUT NOTICE.

For latest information, please visit HEOSbyDenon.com

INTRODUCTION

The HEOS Link is part of the HEOS wireless multi-room sound system that enables you to enjoy your favorite music anywhere and everywhere around your home. By utilizing your existing home network and the HEOS app on your iOS or Android™ device, you can explore, browse, and play music from your own music library or from many online streaming music services.

- True multi-room audio - play different songs in different rooms or the same song in every room
- Utilizes your existing home wireless network for quick and easy setup
- Industry leading microsecond audio synchronization between HEOS device
- Legendary Denon audio quality

If you are in a hurry, you can be enjoying great sounding music in no time by following the steps outlined in the HEOS Quick Start Guide (packaged with your HEOS device).



Please continue reading this Owner's Manual for more detailed information about the features and benefits of your HEOS Link.



BEFORE YOU BEGIN

NOTE

If you have already installed at least one HEOS device, please skip to the section “ADDING MORE HEOS DEVICES” below ([🔍 p. 17](#)).

System Requirements

Before you begin installing your first HEOS device, please make sure you understand and meet a few basic requirements.

■ Network Requirements

Wireless Router - In order to use your HEOS music system, you should have a working wireless (Wi-Fi) network in your home. If you do not have a wireless network, please contact your local Denon dealer or electronics retailer to assist you with purchasing and installing a wireless network in your home.

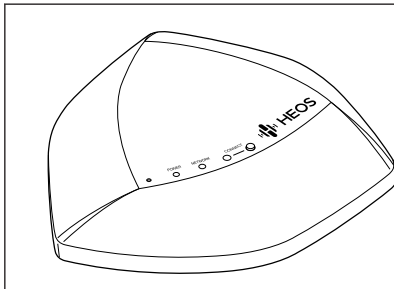

The HEOS Extend Wireless Range Extender (sold separately) is available as an accessory, should you need to setup a new wireless network or extend the range of your existing network. Please contact Denon for more information about the Wireless Extender.

High Speed Internet Connection - HEOS accesses the Internet to stream music to your home from many popular online music services. HEOS is also designed to provide you with software updates, which are delivered via your home Internet connection. DSL, Cable, and Fiber services will provide the best experience and reliability. You may experience performance issues with slower Internet connections like satellite based services.



■ Controller Requirements

You can control your HEOS wireless multi-room sound system using the free HEOS app on any iOS or Android mobile device that meets these minimum requirements:



iOS Minimum Requirements

- iOS version 5.0 or later
- iPhone® 3GS or newer
- iPad®
- iPod touch® (3rd generation) or newer



Android Minimum Requirements

- Android OS version 2.3 or later
- All resolutions



Getting To Know Your HEOS Link

Unpack your HEOS Link from the box and verify that the following items are included:

① HEOS Link

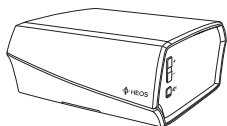

② Quick Start Guide



③ Safety Information Sheets

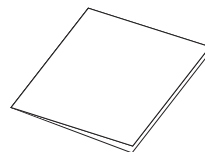

④ Warranty
(North America model only)

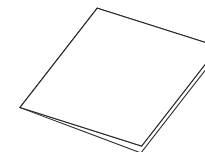

⑤ Extended Protection Plan
(North America model only)

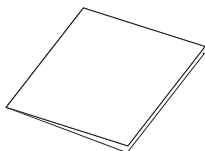

⑥ Audio/Setup cable

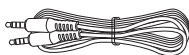

⑦ RCA cable



⑧ Ethernet cable

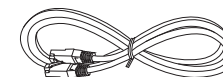

⑨ Power cord

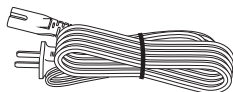

⑩ IR Direct cable

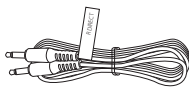

⑪ IR Emitter Cable



NOTE

Please use the power cord included in the box for your device.



■ Front panel

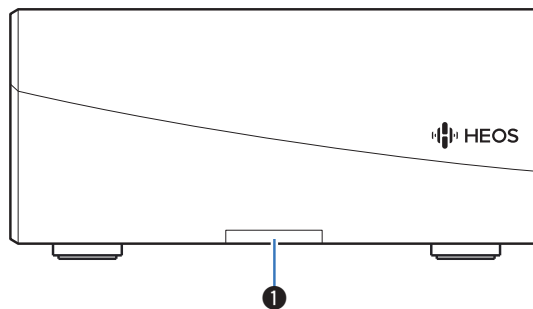

① Status LED

Please refer to the “Status LED Table” for LED color and state meaning “Status LED Table” ([📄 p. 47](#)).



■ Controls

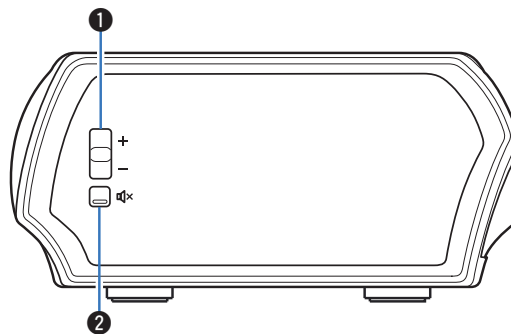

- ❶ **Volume Up/Down buttons (+, -)**
Adjusts the HEOS device's volume level up or down.
- ❷ **Mute button (🔇)**
Mutes or unmutes the HEOS device's volume.



■ Back panel

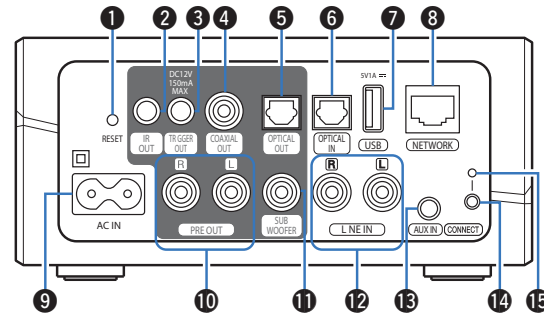

1 Reset Button (RESET)

Various settings are reset to the factory default values. (☞ p. 45)

2 IR Output (IR OUT)

Used to control a Denon AVR, PMA, or System. (☞ p. 37)

3 Trigger Output (DC12 V 150 mA MAX.)

Used to send a 12 V signal to control an external amplifier. (☞ p. 38)

4 Digital Audio Output (COAXIAL OUT)

Used to connect this unit to audio amplifier, AV receiver of audio system. (☞ p. 13)

5 Digital Audio Output (OPTICAL OUT)

Used to connect this unit to audio amplifier, AV receiver of audio system. (☞ p. 13)

6 Digital Audio Input (OPTICAL IN)

Used to connect audio devices with a digital optical cable. (☞ p. 14)

7 USB Input (USB 5 V/1 A)

Used to connect USB storage devices. (☞ p. 14)

8 Network Connector (NETWORK)

Used to connect this unit to a wired Ethernet network. (☞ p. 17)

9 AC input (AC IN)

Used to connect the power cord. (☞ p. 15)

10 Analog Pre Output (PRE OUT)

Used to connect this unit to audio amplifier, AV receiver of audio system. (☞ p. 13)

11 Subwoofer Output (SUB WOOFER)

Used to connect this unit to a powered subwoofer. (☞ p. 13)



12 Analog Line Input (LINE IN)

Used to connect audio devices with a stereo RCA cable.

( [p. 14](#))

13 AUX Input (AUX IN)

Used to connect audio devices with a 3.5 mm cable. ( [p. 14](#))

14 Connect Button (CONNECT)

Used for Wi-Fi setup.

15 Connect in Status LED

Indicates the status of this unit. ( [p. 47](#))



Placing Your HEOS Link

The HEOS Link is designed to add HEOS multi-room audio functionality to an external device which offers audio amplification. You should place your HEOS Link in a convenient location near the amplification device you are connecting it to.

- The HEOS Link must be within range of your wireless network.
- The HEOS Link is not waterproof. Do not place it near any water source and do not leave it outside in the rain or snow.

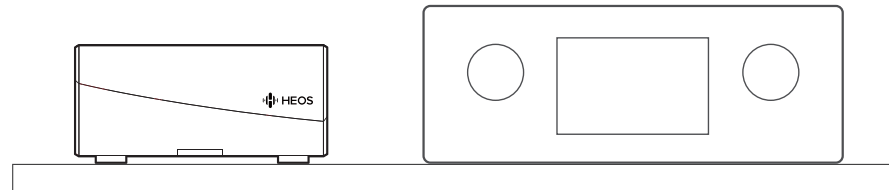

Connecting External Devices

■ Connecting to an Amplifier or AV Receiver

Connect the PRE OUT, COAXIAL OUT, or OPTICAL OUT output to an available input on your amplifier or AV receiver using the appropriate cables.

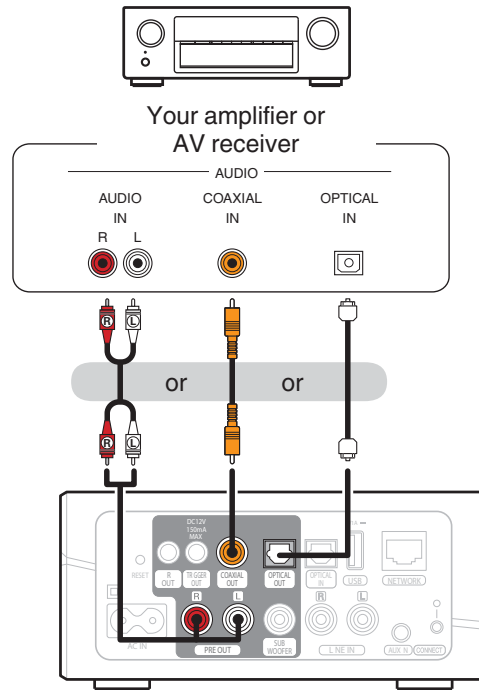

■ Connecting to a Subwoofer

Connect the SUB WOOFER output to an input on your powered subwoofer or your subwoofer amplifier.

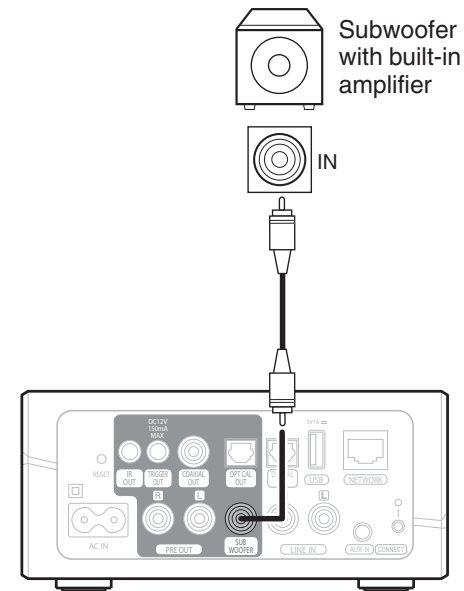

■ Connecting an Audio Playback Device

Connect the LINE IN, AUX IN or OPTICAL IN input to an audio playback device (CD player, portable music player, etc...) using the appropriate cables.

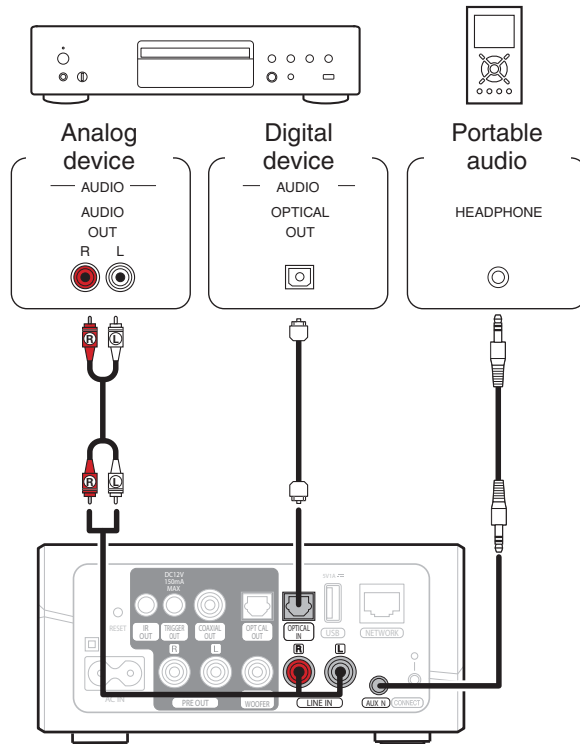

■ Connecting a USB storage device

Connect a FAT32 formatted USB mass storage device containing digital music files to the USB port.

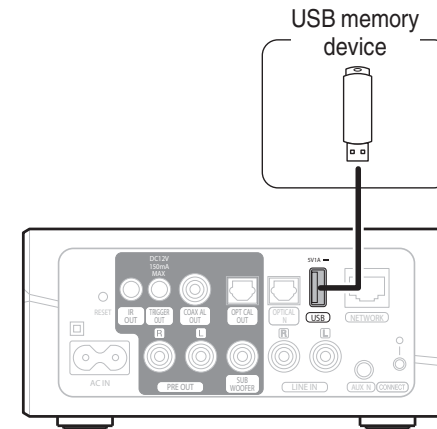

Powering Your HEOS Link

Connect the power cord included in the box to the back of the HEOS Link and the plug to a wall outlet.

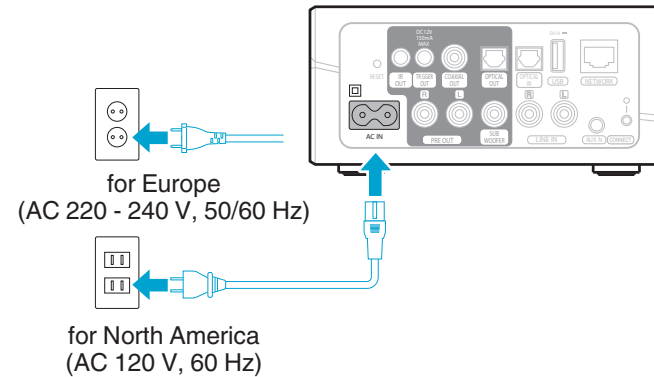

Getting the HEOS App

The HEOS app is the heart of the HEOS experience. Using your mobile device and the HEOS app, you can setup, browse, explore, and control your HEOS system right in the palm of your hand, from anywhere in your home.

Download the HEOS app for iOS or Android by searching App StoreSM or Google PlayTM store for "HEOS by Denon".



SETTING UP YOUR FIRST HEOS LINK

Once you have placed your HEOS Link in your listening room and have downloaded the HEOS app, you are ready to configure your HEOS Link for music playback. This involves following a few simple steps to get the HEOS Link connected to your existing home network:

Caution

DO NOT connect the Ethernet cable if you are connecting your HEOS Link to a wireless network. If you are connecting the HEOS Link to a wired network, use an Ethernet cable to connect the HEOS Link to your network or router.

- 1 Make sure your mobile device is connected to your wireless network (the same network you want your HEOS Link connected to). You can check this in the Settings - Wi-Fi menu of your iOS or Android device.**

NOTE

If your wireless network is secure, make sure you know the password to join your network.

- 2 Make sure you have the included Audio/Setup cable handy.**

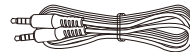

- 3 Launch the HEOS app on your mobile device.**



- 4 Tap the “Setup Now” button at the top of the screen.**
- 5 Follow the instructions to add the HEOS Link to your wireless network. (The Wi-Fi settings from your mobile device will be copied to the HEOS Link via the audio cable.)**

NOTE

If you have any problems connecting your HEOS device, jump to the Troubleshooting section ([🔧 p. 42](#)).



ADDING MORE HEOS DEVICES

The HEOS wireless multi-room sound system is a true multiroom audio system that automatically synchronizes audio playback between multiple HEOS devices so that the audio coming from different rooms is perfectly in sync and always sounds amazing! You can easily add up to 32 devices to your HEOS system.

Adding Wired HEOS Devices

Just connect the HEOS devices to your home network using an Ethernet cable and the HEOS devices will appear on your HEOS app as a new room in the Rooms screen.

At your convenience, you can assign a name to the HEOS devices to indicate which room you have it placed in.



- Use only a shielded STP or ScTP LAN cable which is easily available at electronics stores (CAT 5 or greater recommended).
- Do not connect a Network Connector directly to the LAN port/Ethernet connector on your computer.

Adding Wireless HEOS Devices

You can add additional wireless HEOS devices to your HEOS system by selecting “Add Device” from the HEOS app’s settings menu and follow the instructions:

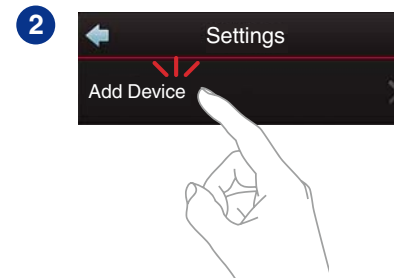
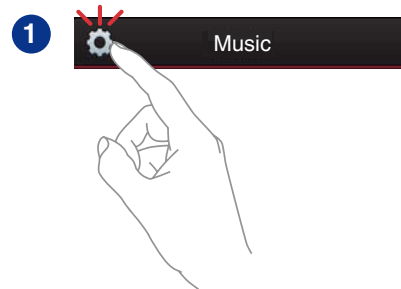

USING YOUR HEOS LINK

Once you have your HEOS Link connected to your network and the HEOS app installed on your mobile device, it's easy to start enjoying your favorite music. You can listen to something different in every room or the same music perfectly synchronized in all rooms. It's up to you!

Selecting a Room

If you have more than one HEOS Link, you must tell the HEOS system which one you want to control:

- 1 Tap the Rooms tab.**
- 2 Select the Room you want to control.**
- 3 Select the Music tab to select a music source or the Now Playing tab to control what is currently playing in the selected room.**

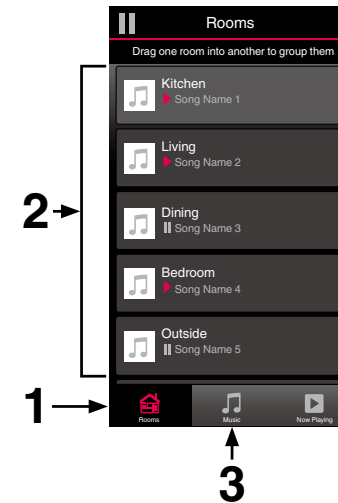

Listening to Radio

The HEOS system includes access to more than 70,000 free internet radio streams from all corners of the globe via the TuneIn radio service. Just select the TuneIn logo from the main Music menu and browse among the 70,000 stations neatly organized into popular categories and select a station that appeals to your mood.

NOTE

If you have a TuneIn account, you can sign into the TuneIn service under Settings Music Sources TuneIn, and access all of your "My Favorite" TuneIn stations.

— Audio signal

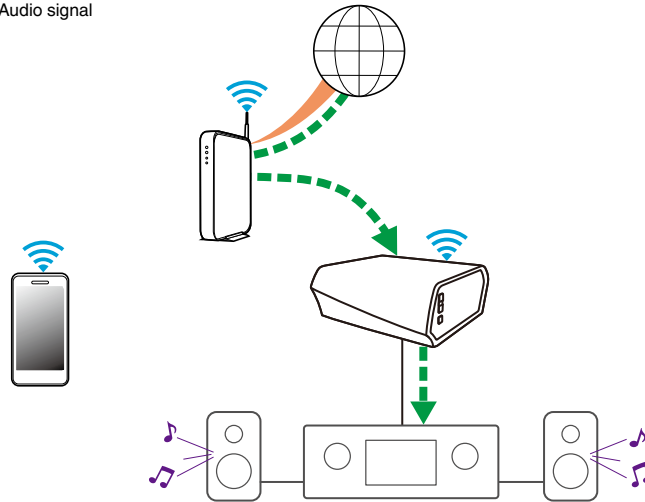

Playing music stored on your mobile device

- 1 Tap the "Music" tab.
- 2 Select "This iPhone/iPod/iPad/Phone".
- 3 Browse the local music on your phone and select something to play.

— Audio signal

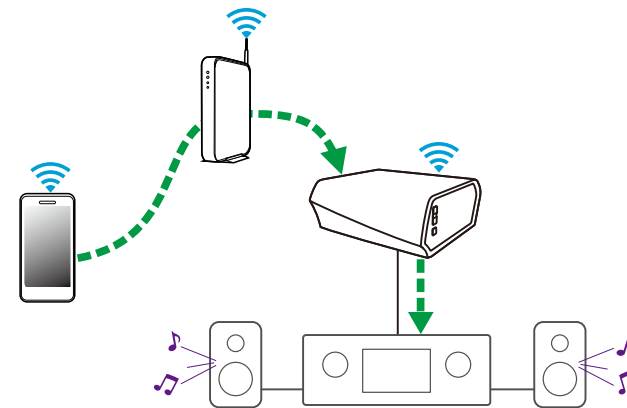

Playing music from your networked PC or NAS

- 1 Select "Local Music" from the Music tab.
- 2 Select the name of your networked PC or NAS (network attached storage) server.
- 3 Browse the music on your PC/NAS and select something to play.

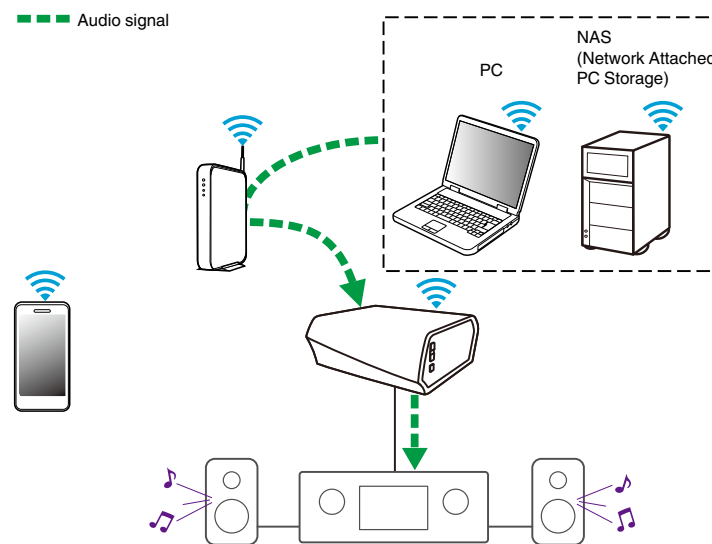

Playing music from an external audio device

- 1** Connect an external audio device to the digital optical, analog RCA stereo or analog 3.5 mm stereo input on the back of the HEOS Link.
- 2** Select “AUX Input” from the Music tab.
- 3** Select the name of the HEOS Link to which you connected the audio device in step 1.
- 4** Select the name of the input to which you connected the audio device in step 1.
- 5** Initiate playback on the audio device.

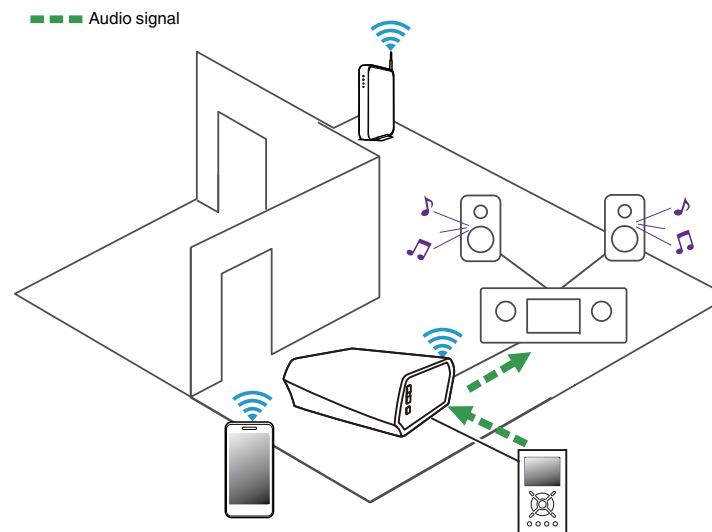

Streaming an external audio device to any HEOS device

The sound from the audio device can be played directly on the selected device or digitized and sent over your network to other HEOS devices.

- 1** Connect an external audio device to the digital optical, analog RCA stereo or analog 3.5 mm stereo input on the back of the HEOS Link.
- 2** Select “AUX Input” from the Music tab.
- 3** Select the name of the HEOS Link to which you connected the audio device in step 1.
- 4** Select the name of the input to which you connected the audio device in step 1.
- 5** Initiate playback on the audio device.

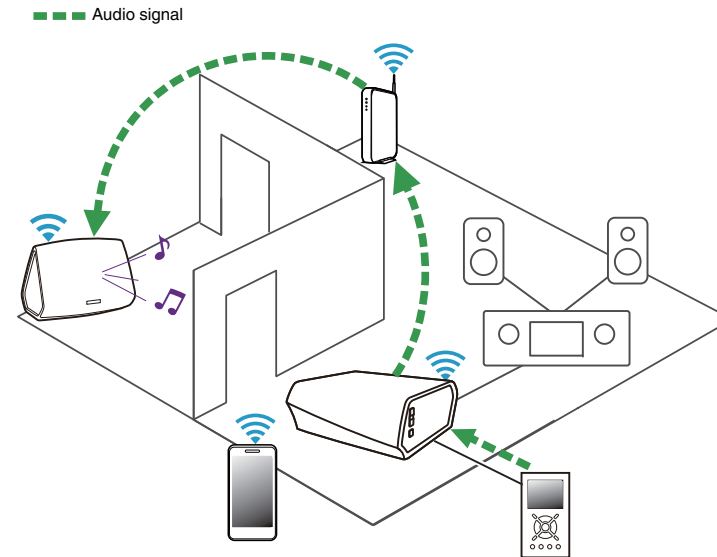

Playing music from a USB device

- 1** Insert a FAT32 formatted USB device into the USB port on the back of the HEOS Link.
- 2** Select “Local Music” from the Music tab.
- 3** Select the name of your HEOS device.
- 4** Browse the music on your USB device and select something to play.

NOTE

- It may take several minutes for the name of your HEOS Link to appear in the Local Music list if you have a large number of files on your USB device.
- It is not possible to connect and use a computer via the USB port of this unit using a USB cable.

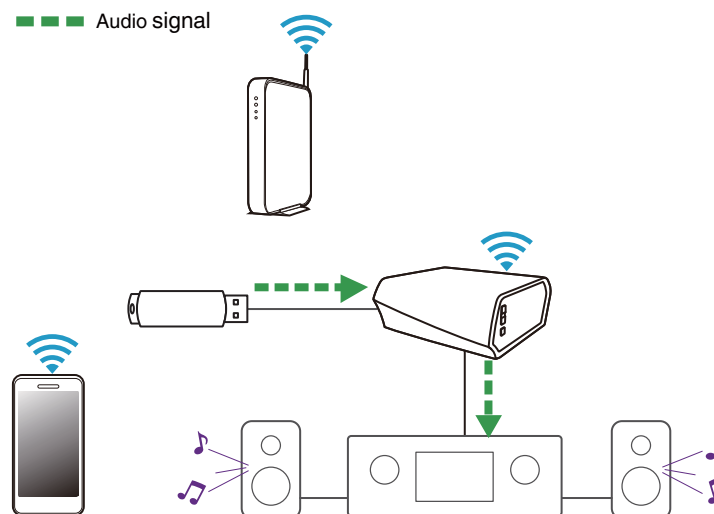

HEOS account

■ What is a HEOS account?

A HEOS account is master account or “keychain” for managing all of your HEOS music services with one single username and password.

■ Why do I need a HEOS account?

With the HEOS account you just have to enter your music services login names and passwords one time. This allows you to easily and quickly use multiple controller apps on different devices. You just log into your HEOS account on any device and you will have access to all of your associated music services, play history and custom playlists, even if you are at a friend’s house listening to music on their HEOS system.

■ Signing up for a HEOS account

You will be instructed to signup for a HEOS account the first time you try to access any music service from the main Music menu of the HEOS app.

■ Changing Your HEOS account

- 1 Tap the Music tab.
- 2 Select the Settings  icon in the upper left corner of the screen.
- 3 Select “HEOS Account”.
- 4 Sign Out, Edit, or Remove your HEOS account from your HEOS system.



Playing from Streaming Music Services

A Music Service is an online music company that provides access to vast music collections via free and/or paid subscriptions. Depending upon your geographical location, there are several options to choose from. For more information about which services are available in your area please visit HEOSbyDenon.com

■ Adding a Music Service

Once you've setup your HEOS account, you can add supported Music Services to your HEOS system by tapping on the music service logo in the Music tab.

Follow the instructions on the screen to add your username and password for the selected music service. You only have to enter your account information once as the HEOS account service will securely remember your login information so you don't have to enter it each time you want to play music from the music service.

Additional Music Services may be available under Settings - Music Services.

■ Changing Music Service Settings

- 1 Tap the "Music" tab.
- 2 Select the Settings  icon in the upper left corner of the screen.
- 3 Select "Music Sources".
- 4 Select the name of the online Music Service you want to edit.
- 5 Sign out, then sign in again to associate your username and password with your HEOS account.
- 6 Select "Hide for Now" to prevent the service logo from appearing on the main Music menu.



Listening To The Same Music In Multiple Rooms

The HEOS system is a true multiroom audio system that automatically synchronizes audio playback between multiple devices so that the audio coming from different rooms is perfectly in sync and always sounds amazing!

You can easily add up to 32 devices to your HEOS system.

You can join or group up to eight individual rooms into a group that functions as if they were a single room.

■ Grouping Rooms

- 1 Tap the “Rooms” tab.
- 2 Press and hold your finger on room that is not playing music.
- 3 Drag it into the room that is playing music (indicated by the red outline) and lift your finger.
- 4 The two rooms will be grouped together into a single device group and both rooms will be playing the same music in perfect sync.

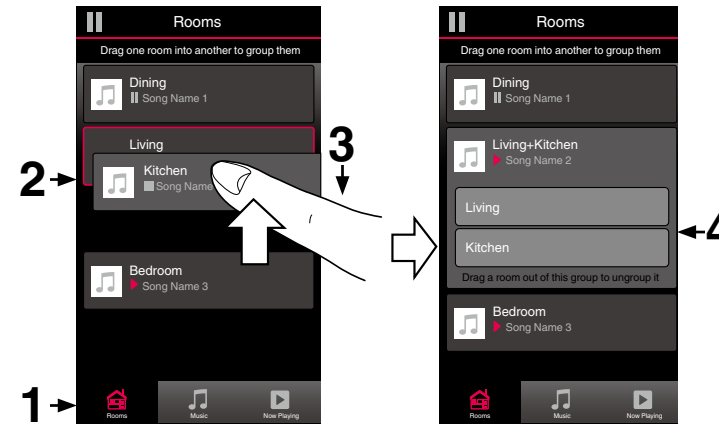

■ Ungrouping Rooms

- 1 Tap the “Rooms” tab.
- 2 Press and hold your finger on room that you want to remove from the group.

NOTE
You can not remove the first room that started playing the music before grouping.
- 3 Drag it out of the group and lift your finger.
- 4 Music will stop playing in the room you dragged out of the group but will continue playing in any remaining rooms.

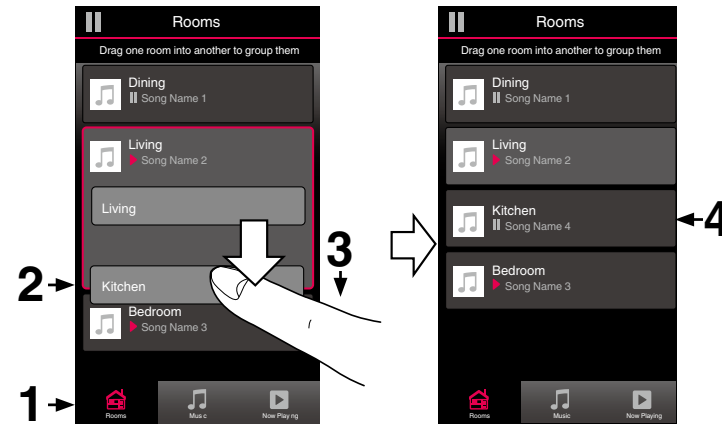

■ Grouping All Rooms (Party Mode)

You can easily group the eight rooms together into Party Mode by using a “pinch” gesture.

- 1 Tap the “Rooms” tab.
- 2 Place two fingers on the screen over the list of rooms.
- 3 Quickly pinch your two fingers together and release.
- 4 All of your rooms will be joined together and begin playing the same music in perfect sync.

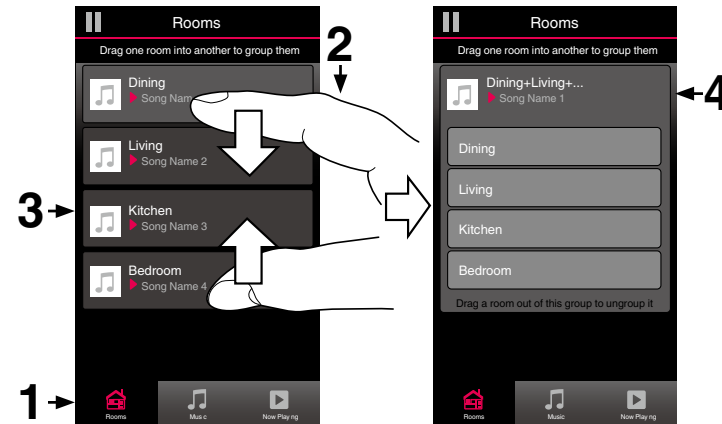

■ Ungrouping All Rooms

You can easily ungroup all of your rooms and exit Party Mode by using a “spread” gesture.

- 1 Tap the “Rooms” tab.
- 2 Place two fingers close together on the screen over list of rooms.
- 3 Quickly spread your two fingers apart from each other and release.
- 4 All of your rooms will be ungrouped and music will stop playing in every room (except the original “master” room that was playing before you grouped the rooms together).

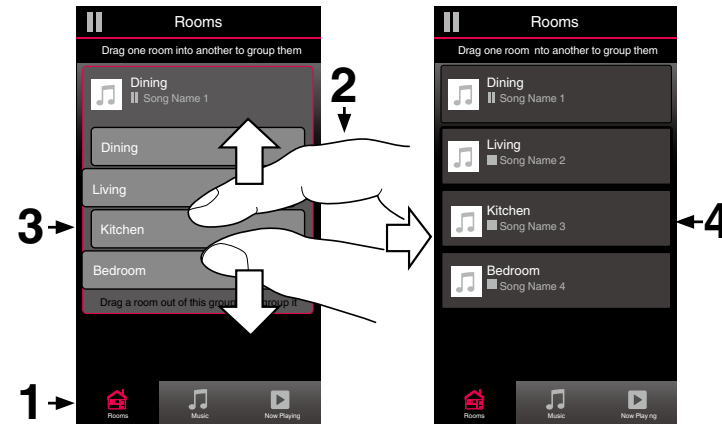

Using the Now Playing Queue

HEOS uses a Now Playing “Queue” to line up music that you want to listen to. Music can be selected from any of your local or online music sources (as long as they are not preprogrammed “radio” or “station” type streams). This feature works similarly to how a jukebox works. You select something to play (a song, album, playlist or even your entire music collection) and add it to the “queue”. When you select something to play you will be asked how you want to queue up your music.

■ Play Now

Inserts the item into the queue after the currently playing track and plays the selected item immediately.

■ Play Now & Replace Queue

Clears the queue and plays the selected item immediately.

■ Play Next

Inserts the item into the queue after the current song and plays it when the current song ends.

■ Add to End of Queue

Adds the item to the end of the queue.

■ Repeat and Shuffle Playback

You can control how the play queue plays the music that you have added by using the Repeat and Shuffle controls. The playback controls are visible on the Now Playing screen.



1 Tap the “Now Playing” tab.

2 Tap the cover art to reveal the repeat and shuffle controls.





Rearranging the Now Playing Queue

Once you have songs lined up in your queue, you might want to rearrange the order or remove some songs:

- 1 Tap the “Now Playing” tab.
- 2 Tap the Queue  icon in the upper right corner of the screen.
- 3 Tap the Pencil  icon to enter Edit mode.
- 4 Rearrange the order of your queue by dragging the list  icon (on the right side of each track row) up or down.

Deleting Songs from the Play Queue



You can remove songs one at a time from the Now Playing queue:

- 1 Tap the “Now Playing” tab.
- 2 Tap the Queue  icon in the upper right corner of the screen.
- 3 Tap the Pencil  icon to enter Edit mode.
- 4 Tap the track(s) that you want to delete.
- 5 Tap the Delete  icon to delete all of the selected tracks from the play queue.





Deleting All Songs from the Play Queue

You can remove all of the songs from the Now Playing queue:

- 1 Tap the “Now Playing” tab.
- 2 Tap the Queue  icon in the upper right corner of the screen.
- 3 Tap the Delete  icon to confirm that you want to delete all songs from the queue.

Saving Playlists

You can save the Now Playing queue as a HEOS Playlist that you can recall later. The new playlist will be available from the Playlists button on the Music tab on every controller app connected to your HEOS system.

- 1 Tap the “Now Playing” tab.
- 2 Tap the Queue  icon in the upper right corner of the screen.
- 3 Tap on the Save  icon.
- 4 Enter a name for your Playlist and tap the Save icon.



MAKING ADJUSTMENTS

You can adjust specific settings for each of your HEOS Links in your system:

- 1 Select the Settings  icon located in the upper left corner of the main Music menu to display the Settings menu.
- 2 Select “My Devices” to display a list of your devices.
- 3 Select the HEOS Link you want to adjust.

Changing the Name of a HEOS Link

- 1 Select “Name”.
- 2 Select or enter a new name for your HEOS Link.
- 3 Select the Save  button to save your changes.

Changing the Wireless Network Connection

- 1 Select “Network”.
- 2 A list of wireless networks that your HEOS Link can access is displayed.
- 3 Select the network you want your HEOS Link to join.
- 4 Wait as the HEOS Link’s network connection is changed.

NOTE

Wired networking is automatically selected when the device is connected to a wired Ethernet network. To switch back to using a wireless network you must remove the Ethernet cable from the back of the device.



Adjusting the Equalizer

- 1 Select “EQ”.
- 2 Adjust the Treble or Bass up or down.



Select the Reset button to restore the default settings.

Adjusting the Audio Quality

Selects the transcoding option for rebroadcasting audio from one HEOS device to another HEOS device (or group of devices) across the network. When set to “Normal”, high bit rate audio sources originating from the first device (such as AUX input, WAV, FLAC and PCM) will be transcoded to ensure the highest level of reliability for the audio stream.

- 1 Select “Quality”.
- 2 Select Normal (default) or High.



If you have selected High and you experience audio dropouts when streaming sources from one device to other devices, please select Normal (default).

Adjusting the Volume Control Method

- 1 Select “Line Out Level”.
- 2 Select Fixed to lock the volume at the optimal level or select Variable to control the volume from the Now Playing screen.

Adjusting the Status Light Brightness

- 1 Select “Status Light”.
- 2 Adjust the brightness up or down or set the slider to the OFF position to completely disable the status light.



Advanced Settings

Caution

Adjusting these settings may disconnect your device from your network and possibly render your device unusable. Do not use these features unless you are comfortable making advanced adjustments.

■ Network Settings

- 1 Select “Advanced”.
- 2 Select “Network Settings”.
- 3 Scroll down to see all of the options for
 - a. Network Interface (wired or wireless)
 - b. Wireless network settings
 - c. Manual or static IP address for your device
- 4 Select **Save Settings** to apply the new settings or **Cancel Changes** to revert to the previous settings.

■ Firmware Upgrade

- 1 Select “Advanced”.
- 2 Select “Firmware Upgrade”.
- 3 Enable or disable automatic firmware upgrades.
- 4 Manually check for a firmware upgrade.
- 5 Select **Save Settings** to apply the new settings or **Cancel Changes** to revert to the previous settings.



■ About

Viewing Technical Details About the HEOS device.

- 1** Select “Advanced”.
- 2** Select “About”.
- 3** Scroll down to see information about the device's
 - a. Hardware
 - b. Software
 - c. Device



External Device Control

The HEOS Link can tightly integrate with most Denon AVR, Preamps, and Hi-Fi systems to allow them to operate as if they were one device.

You can configure your HEOS Link to tell the connected device when to turn on, turn off, select the correct input and adjust volume and mute.

You can adjust specific settings for each of your HEOS Links in your system:

- 1** Select the **Settings**  icon located in the upper left corner of the main Music menu to display the Settings menu.
- 2** Select “My Devices” to display a list of your devices.
- 3** Select “Control”.
- 4** Select the method which is most appropriate for your configuration:

■ IR Control

Connect the appropriate IR control cable between your AV receiver or amplifier and the HEOS Link using the IR direct or IR emitter cable (both included) depending on the IR control input capabilities of your device.

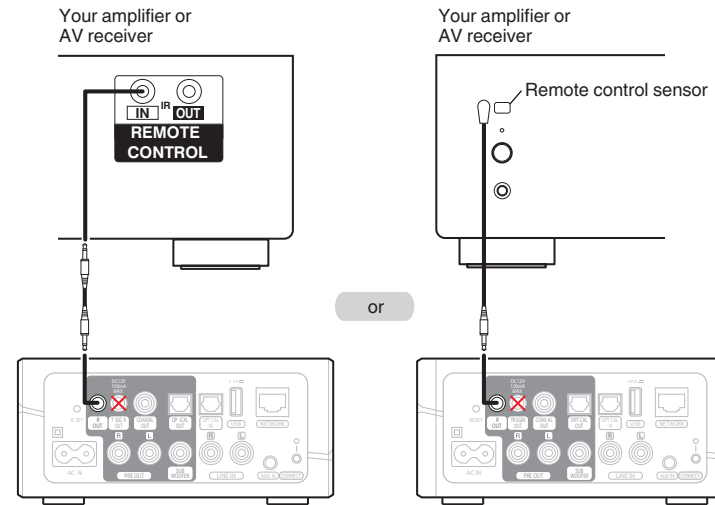

NOTE

Connecting the IR control cable (IR Direct cable/IR Emitter cable) to the Trigger Out connector of the HEOS Link incorrectly may break the connected AV receiver, the amplifier or the IR Emitter cable.



■ Trigger Control

If the power amplifier to be connected to this unit has a trigger input connector, connect it to the TRIGGER OUT jack of this unit using the included IR Direct cable. A signal up to 12 V/150 mA is output from the TRIGGER OUT jack.

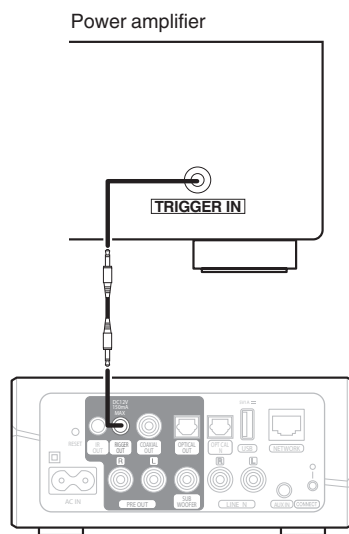

UPDATING YOUR SYSTEM

HEOS has the ability to add enhancements and updated functionality via your high speed Internet connection. When such updates become available, you will be notified when you open the HEOS app. Follow the instructions on the screen to update the HEOS device and/or your controller App.

In the event that you wish to manually initiate an update, please follow these steps:

- 1** Select the Settings  icon located in the upper left corner of the main Music menu to display the Settings menu.
- 2** Select “Check for Update”.
- 3** Follow the instructions on screen to install any available updates to your HEOS system.



ADVANCED FEATURES

There are a few advanced features of the HEOS system that you may want to explore once you become familiar with the basic operations. You can access the advanced features of the HEOS system by following these steps:

- 1** Select the **Settings**  icon located in the upper left corner of the main **Music** menu to display the **Settings** menu.
- 2** Select **“Advanced Settings”** to display a list the available settings.

Submit Diagnostics

If you are having trouble with your network or HEOS system, you may be asked by Denon technical support personnel to select this option. This feature will automatically send Denon technical support diagnostic information about your HEOS system.

NOTE

No personal information is sent and your information will never be shared with anyone.



Sharing Music from your Mobile Device

The HEOS App has a feature called “Music Sharing” which can share the local music stored on your mobile device to other HEOS app users on your local network. To enable this feature, select Music Sharing, and set it on “ON”.

The name of the device you are sharing from will appear as a new Local Music source allowing other HEOS controller apps to browse and play music from the your device.

Resetting Your Controller App

This feature will reset the control app to its original state when you first installed it on your mobile device without requiring you to remove, download, and reinstall it from the app store.

Power Modes

■ Network Standby

To save power, the device will automatically enter “Network Standby” whenever there is no network access or playback for 20 minutes and will automatically resume to full power whenever the device is selected and playing music. There is no visible indicator or LED that will show that the device is in Network Standby as it is a fully automatic function.

■ Deep Standby

The device also has the ability to automatically enter “Deep Standby” whenever the wired or wireless network connection is removed for more than 60 minutes in Network Standby. The front panel LED will turn off during Deep Standby. To “wake” a HEOS device from Deep Standby, you must press the volume or mute buttons which will immediately turn on the front panel LED.

■ Off

To completely turn off the power to the device you must remove the mains plug from the power outlet.



BASIC TROUBLESHOOTING

My HEOS Device won't connect to my network using the audio cable

Solution	Refer to Page
<ul style="list-style-type: none"> • Make sure your mobile device is connected to your wireless network before setting up your device. 	<u>16</u>
<ul style="list-style-type: none"> • Alternatively, you can connect your device to your network router using the included Ethernet cable. Once connected via Ethernet, the HEOS by Denon App should recognize the device and you can manually move it to your wireless network using Settings/My Devices/Device Name/Advanced/Network Settings. 	<u>17</u>

I get a message “Device was not found”

Solution	Refer to Page
<ul style="list-style-type: none"> • Move your HEOS device closer to your wireless router. 	<u>12</u>
<ul style="list-style-type: none"> • Your HEOS devices and controller device may not be on the same network. Verify that the controller device is on the same network as your HEOS devices. This is usually configured under the Settings feature on your mobile device. If you have more than one network, your mobile device may hop to a different network as you move around your home. 	<u>16</u>
<ul style="list-style-type: none"> • Make sure you don't have any other electronic devices interfering with your wireless network signals. Microwave ovens, cordless phones, and some televisions can cause wireless network interference. 	<u>12</u>
<ul style="list-style-type: none"> • If your HEOS devices are located far away from your router, consider adding a Wireless Range Extender like the HEOS Extend. 	<u>5</u>
<ul style="list-style-type: none"> • In case your wireless router is incompatible with HEOS device, please use the optional HEOS Extend Wireless Range Extender and hard-wire it to your router. 	<u>5</u>



I can't control an external device via IR and Trigger

Solution	Refer to Page
<ul style="list-style-type: none">• Check the control cable connection between HEOS Link and the AV receiver or amplifier.	<u>37</u>

I don't hear anything from the Link

Solution	Refer to Page
<ul style="list-style-type: none">• Check the connection between HEOS Link and the AV receiver or amplifier.	<u>13</u>
<ul style="list-style-type: none">• Check that the correct input source is being used for the AV receiver or amplifier.	–
<ul style="list-style-type: none">• Check that HEOS Link and the AV receiver or amplifier are at a suitable volume.	–
<ul style="list-style-type: none">• Check that the external device connected to HEOS Link is connected and playing correctly.	<u>14</u>



Music cuts out or delays sometimes

Solution	Refer to Page
<ul style="list-style-type: none"> • Make sure your Internet connection is operating correctly. If you are sharing your network with other users or devices, they may be using most of your bandwidth (especially if they are streaming video). 	<u>5</u>
<ul style="list-style-type: none"> • Make sure your HEOS devices are within range of your wireless network. 	<u>5</u>
<ul style="list-style-type: none"> • Make sure your HEOS devices are not located near other electronic devices that could interfere with it's wireless connectivity (like microwave ovens, cordless phones, TVs, etc...). 	<u>5</u>

I hear a delay when using the AUX Input with my TV

Solution	Refer to Page
<ul style="list-style-type: none"> • If you are connecting the AUX input with your cable or satellite box for enjoying TV audio through multiple HEOS devices, you may hear a delay between when you see someone speak and when you hear the audio. This is because the HEOS system must buffer the audio before it sends it out to the HEOS devices so that it arrives at all devices at the same time. 	<u>21</u>
<ul style="list-style-type: none"> • You can avoid this delay by listening only to the device which is directly connected to the set top box. 	–

Connecting to a WPS Network

Solution	Refer to Page
<p>If your wireless router support WPS (Wi-Fi Protected Setup™) your HEOS wireless device can optionally connect to your network using the “Push Button” method by following these steps:</p> <ol style="list-style-type: none"> 1. Press the WPS button on your router. 2. Within 2 minutes, Press and Hold the Connect button on the rear panel of the HEOS device for 5 seconds. 3. The LED on the front of the device will flash green for several seconds as it connects to your WPS router. 4. When the connection is complete, the LED on the front of the device will turn solid blue. 	<u>5</u>



Resetting Your HEOS Device

Solution	Refer to Page
<p>Resetting your HEOS device will clear out the wireless network info, EQ, and name but retain it's current software. You will have to use Settings - Add Device to reconnect the HEOS device to your home network before it can be used.</p> <p>To reset your HEOS device, gently insert a small paperclip into the Reset button hole on the back and hold it in until the front LED begins to flash amber.</p>	–

Restoring the HEOS Device to Factory Defaults

Solution	Refer to Page
<p>Restoring the HEOS device to its factory defaults will clear all of the settings and restore the original software which was installed at the factory.</p> <p>Caution</p> <p>All settings will be erased and the software will likely be downgraded!</p> <p>To restore your HEOS device to the factory defaults, unplug the power cable from the power outlet. Insert a small paperclip into the Reset button hole on the back of the HEOS device, reconnect the power cable, and hold it in until the front LED begins to flash amber.</p>	–

* For further information, please visit [HEOSbyDenon.com](https://www.denon.com/HEOSbyDenon.com)



Contact Denon

For U.S. & Canada only:

If you need further assistance with your HEOS product, please contact HEOS by Denon Customer Support Services below:

Website: www.HEOSbyDenon.com/Support

Email: Support@HEOSbyDenon.com

Live Chat: www.HEOSbyDenon.com/LiveChat

Telephone: Toll Free (855) 499 2820







(M-F 10:00AM to 10:00PM EST / Sat 12:00PM to 8:00PM EST)

For the other region:

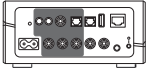
If you need additional help in solving problems, please contact Denon customer service in your area or visit HEOSbyDenon.com

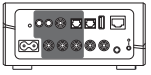

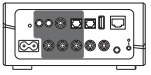
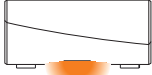
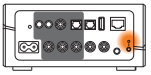
Status LED Table

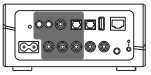
Device Operation	Description	Front LED Action	Rear LED Action
Off	No AC power or Deep Standby	 (off)	 (off)
Plug in	Booting	 (blink)	 (off)
On	Ready-Configured and connected to your network	 (solid)	 (off)
On	Not Connected to your network	 (solid)	 (solid)
Change Network	Connecting to your network	 (blink)	 (off)

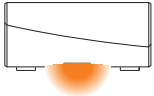
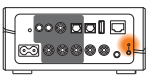
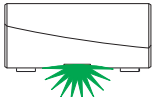
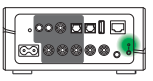
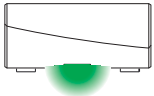
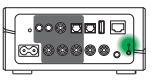
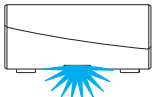
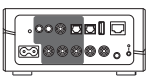

Device Operation	Description	Front LED Action	Rear LED Action
Setup	Not connected	 (solid)	 (solid)
	Connect button was pressed	 (blink)	 (solid)
	Cable connection is OK	 (solid)	 (solid)
	Connecting to your network	 (blink)	 (off)

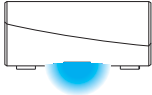
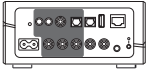
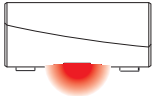
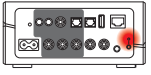
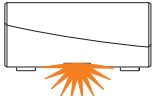
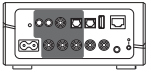
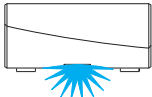
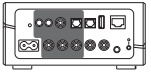
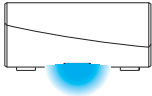
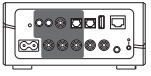

Device Operation	Description	Front LED Action	Rear LED Action
Setup	Configured and connected to your network	 (solid)	 (off)
	Error	 (solid)	 (solid)
Update	Updating	 (blink)	 (off)
	Rebooting	 (blink)	 (off)
	Ready-Configured and connected to your network	 (solid)	 (off)

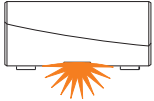
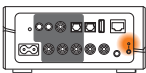
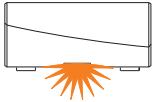
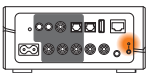
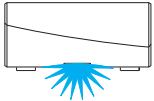
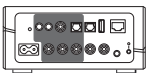
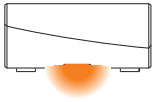
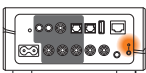

Device Operation	Description	Front LED Action	Rear LED Action
Reset	Soft reset - Clear user settings	 (fast blink)	 (solid)
	Hard reset - Factory restore	 (blink)	 (solid)
	Rebooting	 (blink)	 (off)
	Ready-Not Configured	 (solid)	 (solid)

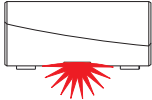
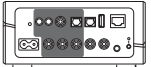
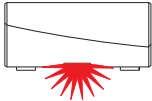
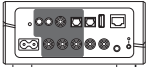
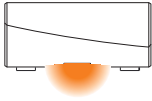
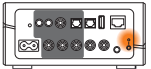
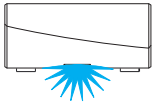
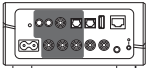
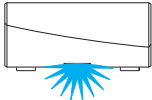
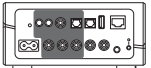

Device Operation	Description	Front LED Action	Rear LED Action
Errors	Firmware Error	 (slow blink (NOT fade))	 (off)
	Hardware Error	 (fast blink)	 (off)
	Network Error	 (solid)	 (solid)
Volume Change	 (quick blink)	 (off)	
Mute	 (slow blink)	 (off)	

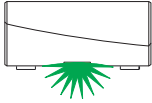
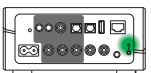
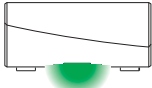
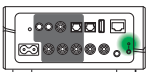
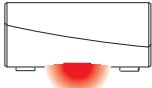
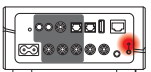
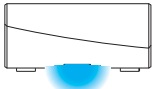
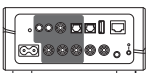
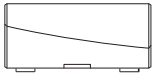
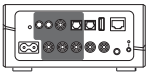

Device Operation	Description	Front LED Action	Rear LED Action
WPS	a WPS session is active	 (fast blink)	 (solid)
	WPS connected	 (for 3 sec. solid)	 (solid)
	WPS time-out	 (for 3 sec. solid)	 (solid)
Power Management	Network Standby	 (dimmed solid)	 (off)
	Deep Standby	 (off)	 (off)



Supported File Types and Codecs

Frequency	Sample Rate	File Extension	Codec	Bit Rates
32 kHz 44.1 kHz 48 kHz	16 bit	wav	PCM	---
32 kHz 44.1 kHz 48 kHz	16 bit	mp3	MPEG-1 Audio Layer 3 CBR/VBR	32 - 320 kbps
32 kHz 44.1 kHz 48 kHz	16 bit	m4a aac	AAC-LC	48 - 320 kbps
32 kHz 44.1 kHz 48 kHz	16 bit	wma	wma9 CBR	CBR:48 - 192 kbps
44.1 kHz 48 kHz	16 bit	flac	flac	---

NOTE

Files protected by DRM such as Apple's Fairplay DRM, are not supported.



SPECIFICATIONS

■ Audio section

THD+N:	ANALOG IN: 0.004 %(1 kHz)
S/N ratio:	ANALOG IN: 90 dB (Audible Range)
Frequency response:	20 Hz to 20 kHz: ± 0.5 dB

■ Wireless LAN section

Network type:	Conforming to IEEE 802.11a/b/g/n
Used frequency range:	2.4 GHz, 5 GHz

■ General

Operating temperature:	41 °F - 95 °F (5 °C - 35 °C)
Power supply:	AC 120 V, 60 Hz (for North America) AC 220 - 240 V, 50/60 Hz (for Europe)
Power consumption:	20 W
Power consumption in network standby mode:	4 W
Power consumption in deep standby mode:	0.3 W

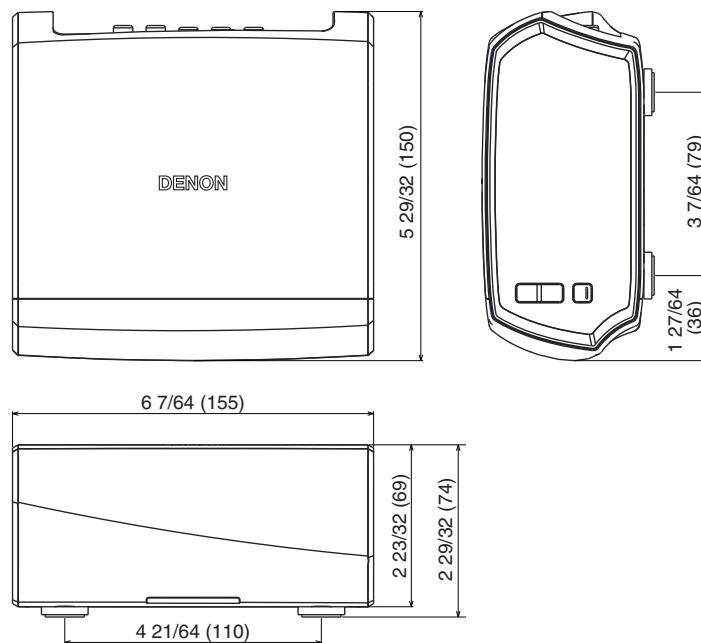

■ Dimensions (Unit : in. (mm))**■ Weight : 2 lbs 13.9 oz (1.3 kg)**

For the purpose of improvement, the specifications and design are subject to change without notice.



INFORMATION

Trademarks



Google Play is a trademark of Google Inc.



Apple, the Apple logo, iPad, iPhone, and iPod touch are trademarks of Apple Inc., registered in the U.S. and other countries. App Store is a service mark of Apple Inc.



Wi-Fi Protected Setup™ logo is trademark of Wi-Fi Alliance.



Adobe, the Adobe logo and Reader are either registered trademarks or trademarks of Adobe Systems Incorporated in the United States and/or other countries.



License

■ License Information for the Software Used in the Unit

About GPL (GNU-General Public License), LGPL (GNU Lesser General Public License) License

This product uses GPL/LGPL software and software made by other companies.

After you purchase this product, you may procure, modify or distribute the source code of the GPL/LGPL software that is used in the product.

Denon provides the source code based on the GPL and LGPL licenses at the actual cost upon your request to our customer service center. However, note that we make no guarantees concerning the source code. Please also understand that we do not offer support for the contents of the source code.

This section describes software license used for this unit. To maintain the correct content, the original (English) is used.

□ GPL

Open Source Used	Version
bridge-utils	2.8
busybox	1.21.1
ebtables	2.0.10-4
Linux kernel	2.6.30
mtd-utils	1.4.3
ntfs-3g ntfsprogs	2011.4.12
ntpclient	2007
u-boot	2011.06
wireless-tools	version 29

□ LGPL

Open Source Used	Version
ffmpeg	0.8.3
glibc	2.9
libmms	0.6.2

□ curl-7.24.0

COPYRIGHT AND PERMISSION NOTICE

Copyright (c) 1996 - 2014, Daniel Stenberg, <daniel@haxx.se>.

All rights reserved.

Permission to use, copy, modify, and distribute this software for any purpose with or without fee is hereby granted, provided that the above copyright notice and this permission notice appear in all copies.

THE SOFTWARE IS PROVIDED "AS IS", WITHOUT WARRANTY OF ANY KIND, EXPRESS OR IMPLIED, INCLUDING BUT NOT LIMITED TO THE WARRANTIES OF MERCHANTABILITY, FITNESS FOR A PARTICULAR PURPOSE AND NONINFRINGEMENT OF THIRD PARTY RIGHTS. IN NO EVENT SHALL THE AUTHORS OR COPYRIGHT HOLDERS BE LIABLE FOR ANY CLAIM, DAMAGES OR OTHER LIABILITY, WHETHER IN AN ACTION OF CONTRACT, TORT OR OTHERWISE, ARISING FROM, OUT OF OR IN CONNECTION WITH THE SOFTWARE OR THE USE OR OTHER DEALINGS IN THE SOFTWARE.

Except as contained in this notice, the name of a copyright holder shall not be used in advertising or otherwise to promote the sale, use or other dealings in this Software without prior written authorization of the copyright holder.



❑ e2fsprogs-libs-1.40.8/lib/uuid

Redistribution and use in source and binary forms, with or without modification, are permitted provided that the following conditions are met:

1. Redistributions of source code must retain the above copyright notice, and the entire permission notice in its entirety, including the disclaimer of warranties.
2. Redistributions in binary form must reproduce the above copyright notice, this list of conditions and the following disclaimer in the documentation and/or other materials provided with the distribution.
3. The name of the author may not be used to endorse or promote products derived from this software without specific prior written permission.

THIS SOFTWARE IS PROVIDED "AS IS" AND ANY EXPRESS OR IMPLIED WARRANTIES, INCLUDING, BUT NOT LIMITED TO, THE IMPLIED WARRANTIES OF MERCHANTABILITY AND FITNESS FOR A PARTICULAR PURPOSE, ALL OF WHICH ARE HEREBY DISCLAIMED. IN NO EVENT SHALL THE AUTHOR BE LIABLE FOR ANY DIRECT, INDIRECT, INCIDENTAL, SPECIAL, EXEMPLARY, OR CONSEQUENTIAL DAMAGES (INCLUDING, BUT NOT LIMITED TO, PROCUREMENT OF SUBSTITUTE GOODS OR SERVICES; LOSS OF USE, DATA, OR PROFITS; OR BUSINESS INTERRUPTION) HOWEVER CAUSED AND ON ANY THEORY OF LIABILITY, WHETHER IN CONTRACT, STRICT LIABILITY, OR TORT (INCLUDING NEGLIGENCE OR OTHERWISE) ARISING IN ANY WAY OUT OF THE USE OF THIS SOFTWARE, EVEN IF NOT ADVISED OF THE POSSIBILITY OF SUCH DAMAGE.

❑ expat-2.0.1

Copyright (c) 1998, 1999, 2000 Thai Open Source Software Center Ltd and Clark Cooper

Copyright (c) 2001, 2002, 2003, 2004, 2005, 2006 Expat maintainers.

Permission is hereby granted, free of charge, to any person obtaining a copy of this software and associated documentation files (the "Software"), to deal in the Software without restriction, including without limitation the rights to use, copy, modify, merge, publish, distribute, sublicense, and/or sell copies of the Software, and to permit persons to whom the Software is furnished to do so, subject to the following conditions:

The above copyright notice and this permission notice shall be included in all copies or substantial portions of the Software.

THE SOFTWARE IS PROVIDED "AS IS", WITHOUT WARRANTY OF ANY KIND, EXPRESS OR IMPLIED, INCLUDING BUT NOT LIMITED TO THE WARRANTIES OF MERCHANTABILITY, FITNESS FOR A PARTICULAR PURPOSE AND NONINFRINGEMENT.

IN NO EVENT SHALL THE AUTHORS OR COPYRIGHT HOLDERS BE LIABLE FOR ANY CLAIM, DAMAGES OR OTHER LIABILITY, WHETHER IN AN ACTION OF CONTRACT, TORT OR OTHERWISE, ARISING FROM, OUT OF OR IN CONNECTION WITH THE SOFTWARE OR THE USE OR OTHER DEALINGS IN THE SOFTWARE.



❑ getopt

<http://cvsweb.netbsd.org/bsdweb.cgi/src/lib/libc/stdlib/>
Copyright (c) 1987, 1993, 1994 The Regents of the University of California. All rights reserved.

Redistribution and use in source and binary forms, with or without modification, are permitted provided that the following conditions are met:

1. Redistributions of source code must retain the above copyright notice, this list of conditions and the following disclaimer.
2. Redistributions in binary form must reproduce the above copyright notice, this list of conditions and the following disclaimer in the documentation and/or other materials provided with the distribution.
3. Neither the name of the University nor the names of its contributors may be used to endorse or promote products derived from this software without specific prior written permission.

THIS SOFTWARE IS PROVIDED BY THE REGENTS AND CONTRIBUTORS "AS IS" AND ANY EXPRESS OR IMPLIED WARRANTIES, INCLUDING, BUT NOT LIMITED TO, THE IMPLIED WARRANTIES OF MERCHANTABILITY AND FITNESS FOR A PARTICULAR PURPOSE ARE DISCLAIMED. IN NO EVENT SHALL THE REGENTS OR CONTRIBUTORS BE LIABLE FOR ANY DIRECT, INDIRECT, INCIDENTAL, SPECIAL, EXEMPLARY, OR CONSEQUENTIAL DAMAGES (INCLUDING, BUT NOT LIMITED TO, PROCUREMENT OF SUBSTITUTE GOODS OR SERVICES; LOSS OF USE, DATA, OR PROFITS; OR BUSINESS INTERRUPTION) HOWEVER CAUSED AND ON ANY THEORY OF LIABILITY, WHETHER IN CONTRACT, STRICT LIABILITY, OR TORT (INCLUDING NEGLIGENCE OR OTHERWISE) ARISING IN ANY WAY OUT OF THE USE OF THIS SOFTWARE, EVEN IF ADVISED OF THE POSSIBILITY OF SUCH DAMAGE.

❑ jQuery

Copyright 2014 jQuery Foundation and other contributors
<http://jquery.com/>

Permission is hereby granted, free of charge, to any person obtaining a copy of this software and associated documentation files (the "Software"), to deal in the Software without restriction, including without limitation the rights to use, copy, modify, merge, publish, distribute, sublicense, and/or sell copies of the Software, and to permit persons to whom the Software is furnished to do so, subject to the following conditions:

The above copyright notice and this permission notice shall be included in all copies or substantial portions of the Software.

THE SOFTWARE IS PROVIDED "AS IS", WITHOUT WARRANTY OF ANY KIND, EXPRESS OR IMPLIED, INCLUDING BUT NOT LIMITED TO THE WARRANTIES OF MERCHANTABILITY, FITNESS FOR A PARTICULAR PURPOSE AND NONINFRINGEMENT. IN NO EVENT SHALL THE AUTHORS OR COPYRIGHT HOLDERS BE LIABLE FOR ANY CLAIM, DAMAGES OR OTHER LIABILITY, WHETHER IN AN ACTION OF CONTRACT, TORT OR OTHERWISE, ARISING FROM, OUT OF OR IN CONNECTION WITH THE SOFTWARE OR THE USE OR OTHER DEALINGS IN THE SOFTWARE.



❑ libpcap-1.4.0

License: BSD

Redistribution and use in source and binary forms, with or without modification, are permitted provided that the following conditions are met:

1. Redistributions of source code must retain the above copyright notice, this list of conditions and the following disclaimer.
2. Redistributions in binary form must reproduce the above copyright notice, this list of conditions and the following disclaimer in the documentation and/or other materials provided with the distribution.
3. The names of the authors may not be used to endorse or promote products derived from this software without specific prior written permission.

THIS SOFTWARE IS PROVIDED "AS IS" AND WITHOUT ANY EXPRESS OR IMPLIED WARRANTIES, INCLUDING, WITHOUT LIMITATION, THE IMPLIED WARRANTIES OF MERCHANTABILITY AND FITNESS FOR A PARTICULAR PURPOSE.

❑ libtar-1.2.11

Copyright (c) 1998-2003 University of Illinois Board of Trustees

Copyright (c) 1998-2003 Mark D. Roth

All rights reserved.

Developed by: Campus Information Technologies and Educational Services, University of Illinois at Urbana-Champaign

Permission is hereby granted, free of charge, to any person obtaining a copy of this software and associated documentation files (the "Software"), to deal with the Software without restriction, including without limitation the rights to use, copy, modify, merge, publish, distribute, sublicense, and/or sell copies of the Software, and to permit persons to whom the Software is furnished to do so, subject to the following conditions:

- * Redistributions of source code must retain the above copyright notice, this list of conditions and the following disclaimers.
- * Redistributions in binary form must reproduce the above copyright notice, this list of conditions and the following disclaimers in the documentation and/or other materials provided with the distribution.
- * Neither the names of Campus Information Technologies and Educational Services, University of Illinois at Urbana-Champaign, nor the names of its contributors may be used to endorse or promote products derived from this Software without specific prior written permission.

THE SOFTWARE IS PROVIDED "AS IS", WITHOUT WARRANTY OF ANY KIND, EXPRESS OR IMPLIED, INCLUDING BUT NOT LIMITED TO THE WARRANTIES OF MERCHANTABILITY, FITNESS FOR A PARTICULAR PURPOSE AND NONINFRINGEMENT.

IN NO EVENT SHALL THE CONTRIBUTORS OR COPYRIGHT HOLDERS BE LIABLE FOR ANY CLAIM, DAMAGES OR OTHER LIABILITY, WHETHER IN AN ACTION OF CONTRACT, TORT OR OTHERWISE, ARISING FROM, OUT OF OR IN CONNECTION WITH THE SOFTWARE OR THE USE OR OTHER DEALINGS WITH THE SOFTWARE.



❑ mDNS 320.10.80

The majority of the source code in the mDNSResponder project is licensed under the terms of the Apache License, Version 2.0, available from:

<<http://www.apache.org/licenses/LICENSE-2.0>>

To accommodate license compatibility with the widest possible range of client code licenses, the shared library code, which is linked at runtime into the same address space as the client using it, is licensed under the terms of the “Three-Clause BSD License”.

The Linux Name Service Switch code, contributed by National ICT Australia Ltd (NICTA) is licensed under the terms of the NICTA Public Software Licence (which is substantially similar to the “Three-Clause BSD License”, with some additional language pertaining to Australian law).

❑ mongoose

<https://github.com/cesanta/mongoose/>

Copyright (c) 2004-2013 Sergey Lyubka

Permission is hereby granted, free of charge, to any person obtaining a copy of this software and associated documentation files (the “Software”), to deal in the Software without restriction, including without limitation the rights to use, copy, modify, merge, publish, distribute, sublicense, and/or sell copies of the Software, and to permit persons to whom the Software is furnished to do so, subject to the following conditions:

The above copyright notice and this permission notice shall be included in all copies or substantial portions of the Software.

THE SOFTWARE IS PROVIDED “AS IS”, WITHOUT WARRANTY OF ANY KIND, EXPRESS OR IMPLIED, INCLUDING BUT NOT LIMITED TO THE WARRANTIES OF MERCHANTABILITY, FITNESS FOR A PARTICULAR PURPOSE AND NONINFRINGEMENT. IN NO EVENT SHALL THE AUTHORS OR COPYRIGHT HOLDERS BE LIABLE FOR ANY CLAIM, DAMAGES OR OTHER LIABILITY, WHETHER IN AN ACTION OF CONTRACT, TORT OR OTHERWISE, ARISING FROM, OUT OF OR IN CONNECTION WITH THE SOFTWARE OR THE USE OR OTHER DEALINGS IN THE SOFTWARE.



❑ openssl-1.0.0d

Copyright (c) 1998-2011 The OpenSSL Project. All rights reserved.

Redistribution and use in source and binary forms, with or without modification, are permitted provided that the following conditions are met:

1. Redistributions of source code must retain the above copyright notice, this list of conditions and the following disclaimer.
2. Redistributions in binary form must reproduce the above copyright notice, this list of conditions and the following disclaimer in the documentation and/or other materials provided with the distribution.
3. All advertising materials mentioning features or use of this software must display the following acknowledgment:
"This product includes software developed by the OpenSSL Project for use in the OpenSSL Toolkit. (<http://www.openssl.org/>)"
4. The names "OpenSSL Toolkit" and "OpenSSL Project" must not be used to endorse or promote products derived from this software without prior written permission. For written permission, please contact openssl-core@openssl.org.
5. Products derived from this software may not be called "OpenSSL" nor may "OpenSSL" appear in their names without prior written permission of the OpenSSL Project.
6. Redistributions of any form whatsoever must retain the following acknowledgment:
"This product includes software developed by the OpenSSL Project for use in the OpenSSL Toolkit (<http://www.openssl.org/>)"

THIS SOFTWARE IS PROVIDED BY THE OpenSSL PROJECT "AS IS" AND ANY EXPRESSED OR IMPLIED WARRANTIES, INCLUDING, BUT NOT LIMITED TO, THE IMPLIED WARRANTIES OF MERCHANTABILITY AND FITNESS FOR A PARTICULAR PURPOSE ARE DISCLAIMED. IN NO EVENT SHALL THE OpenSSL PROJECT OR ITS CONTRIBUTORS BE LIABLE FOR ANY DIRECT, INDIRECT, INCIDENTAL, SPECIAL, EXEMPLARY, OR CONSEQUENTIAL DAMAGES (INCLUDING, BUT NOT LIMITED TO, PROCUREMENT OF SUBSTITUTE GOODS OR SERVICES; LOSS OF USE, DATA, OR PROFITS; OR BUSINESS INTERRUPTION) HOWEVER CAUSED AND ON ANY THEORY OF LIABILITY, WHETHER IN CONTRACT, STRICT LIABILITY, OR TORT (INCLUDING NEGLIGENCE OR OTHERWISE) ARISING IN ANY WAY OUT OF THE USE OF THIS SOFTWARE, EVEN IF ADVISED OF THE POSSIBILITY OF SUCH DAMAGE.

This product includes cryptographic software written by Eric Young (ey@cryptsoft.com). This product includes software written by Tim Hudson (tjh@cryptsoft.com).



❑ portmap-6.0

Copyright (c) 1990 The Regents of the University of California.

* All rights reserved.

* Redistribution and use in source and binary forms, with or without modification, are permitted provided that the following conditions are met:

1. Redistributions of source code must retain the above copyright notice, this list of conditions and the following disclaimer.
2. Redistributions in binary form must reproduce the above copyright notice, this list of conditions and the following disclaimer in the documentation and/or other materials provided with the distribution.
3. All advertising materials mentioning features or use of this software must display the following acknowledgement:
This product includes software developed by the University of California, Berkeley and its contributors.
4. Neither the name of the University nor the names of its contributors may be used to endorse or promote products derived from this software without specific prior written permission.

* THIS SOFTWARE IS PROVIDED BY THE REGENTS AND CONTRIBUTORS "AS IS" AND ANY EXPRESS OR IMPLIED WARRANTIES, INCLUDING, BUT NOT LIMITED TO, THE IMPLIED WARRANTIES OF MERCHANTABILITY AND FITNESS FOR A PARTICULAR PURPOSE ARE DISCLAIMED. IN NO EVENT SHALL THE REGENTS OR CONTRIBUTORS BE LIABLE FOR ANY DIRECT, INDIRECT, INCIDENTAL, SPECIAL, EXEMPLARY, OR CONSEQUENTIAL DAMAGES (INCLUDING, BUT NOT LIMITED TO, PROCUREMENT OF SUBSTITUTE GOODS OR SERVICES; LOSS OF USE, DATA, OR PROFITS; OR BUSINESS INTERRUPTION) HOWEVER CAUSED AND ON ANY THEORY OF LIABILITY, WHETHER IN CONTRACT, STRICT LIABILITY, OR TORT (INCLUDING NEGLIGENCE OR OTHERWISE) ARISING IN ANY WAY OUT OF THE USE OF THIS SOFTWARE, EVEN IF ADVISED OF THE POSSIBILITY OF SUCH DAMAGE.

❑ pstdint.h-0.1.12

* BSD License:

* Copyright (c) 2005-2011 Paul Hsieh

* All rights reserved.

* Redistribution and use in source and binary forms, with or without modification, are permitted provided that the following conditions are met:

1. Redistributions of source code must retain the above copyright notice, this list of conditions and the following disclaimer.
2. Redistributions in binary form must reproduce the above copyright notice, this list of conditions and the following disclaimer in the documentation and/or other materials provided with the distribution.
3. The name of the author may not be used to endorse or promote products derived from this software without specific prior written permission.

* THIS SOFTWARE IS PROVIDED BY THE AUTHOR "AS IS" AND ANY EXPRESS OR IMPLIED WARRANTIES, INCLUDING, BUT NOT LIMITED TO, THE IMPLIED WARRANTIES OF MERCHANTABILITY AND FITNESS FOR A PARTICULAR PURPOSE ARE DISCLAIMED.

* IN NO EVENT SHALL THE AUTHOR BE LIABLE FOR ANY DIRECT, INDIRECT, INCIDENTAL, SPECIAL, EXEMPLARY, OR CONSEQUENTIAL DAMAGES (INCLUDING, BUT NOT LIMITED TO, PROCUREMENT OF SUBSTITUTE GOODS OR SERVICES; LOSS OF USE, DATA, OR PROFITS; OR BUSINESS INTERRUPTION) HOWEVER CAUSED AND ON ANY THEORY OF LIABILITY, WHETHER IN CONTRACT, STRICT LIABILITY, OR TORT (INCLUDING NEGLIGENCE OR OTHERWISE) ARISING IN ANY WAY OUT OF THE USE OF THIS SOFTWARE, EVEN IF ADVISED OF THE POSSIBILITY OF SUCH DAMAGE.



❑ **rl78flash 2000.3.1**

License

=====

The MIT License (MIT)

Copyright (c) 2012 Maxim Salov

Permission is hereby granted, free of charge, to any person obtaining a copy of this software and associated documentation files (the “Software”), to deal in the Software without restriction, including without limitation the rights to use, copy, modify, merge, publish, distribute, sublicense, and/or sell copies of the Software, and to permit persons to whom the Software is furnished to do so, subject to the following conditions:

The above copyright notice and this permission notice shall be included in all copies or substantial portions of the Software.

THE SOFTWARE IS PROVIDED “AS IS”, WITHOUT WARRANTY OF ANY KIND, EXPRESS OR IMPLIED, INCLUDING BUT NOT LIMITED TO THE WARRANTIES OF MERCHANTABILITY, FITNESS FOR A PARTICULAR PURPOSE AND NONINFRINGEMENT. IN NO EVENT SHALL THE AUTHORS OR COPYRIGHT HOLDERS BE LIABLE FOR ANY CLAIM, DAMAGES OR OTHER LIABILITY, WHETHER IN AN ACTION OF CONTRACT, TORT OR OTHERWISE, ARISING FROM, OUT OF OR IN CONNECTION WITH THE SOFTWARE OR THE USE OR OTHER DEALINGS IN THE SOFTWARE.

❑ **sqlite 2003.5.7**

SQLite Copyright

SQLite is in the

Public Domain

All of the code and documentation in SQLite has been dedicated to the public domain by the authors. All code authors, and representatives of the companies they work for, have signed affidavits dedicating their contributions to the public domain and originals of those signed affidavits are stored in a firesafe at the main offices of Hwaci. Anyone is free to copy, modify, publish, use, compile, sell, or distribute the original SQLite code, either in source code form or as a compiled binary, for any purpose, commercial or non-commercial, and by any means.

The previous paragraph applies to the deliverable code and documentation in SQLite - those parts of the SQLite library that you actually bundle and ship with a larger application. Some scripts used as part of the build process (for example the “configure” scripts generated by autoconf) might fall under other open-source licenses. Nothing from these build scripts ever reaches the final deliverable SQLite library, however, and so the licenses associated with those scripts should not be a factor in assessing your rights to copy and use the SQLite library.

All of the deliverable code in SQLite has been written from scratch. No code has been taken from other projects or from the open internet. Every line of code can be traced back to its original author, and all of those authors have public domain dedications on file. So the SQLite code base is clean and is uncontaminated with licensed code from other projects.



❑ **strcpy.c , v1.11**

- * Copyright (c) 1998 Todd C. Miller <Todd.Miller@courtesan.com>
- * Permission to use, copy, modify, and distribute this software for any purpose with or without fee is hereby granted, provided that the above copyright notice and this permission notice appear in all copies.
- * THE SOFTWARE IS PROVIDED “AS IS” AND THE AUTHOR DISCLAIMS ALL WARRANTIES WITH REGARD TO THIS SOFTWARE INCLUDING ALL IMPLIED WARRANTIES OF MERCHANTABILITY AND FITNESS. IN NO EVENT SHALL THE AUTHOR BE LIABLE FOR ANY SPECIAL, DIRECT, INDIRECT, OR CONSEQUENTIAL DAMAGES OR ANY DAMAGES WHATSOEVER RESULTING FROM LOSS OF USE, DATA OR PROFITS, WHETHER IN AN ACTION OF CONTRACT, NEGLIGENCE OR OTHER TORTIOUS ACTION, ARISING OUT OF OR IN CONNECTION WITH THE USE OR PERFORMANCE OF THIS SOFTWARE.

❑ **taglib-1.5**

copyright : (C) 2002 - 2008 by Scott Wheeler
email : wheeler@kde.org

“The contents of this file are subject to the Mozilla Public License Version 1.1 (the “License”); you may not use this file except in compliance with the License. You may obtain a copy of the License at <http://www.mozilla.org/MPL/>

Software distributed under the License is distributed on an “AS IS” basis, WITHOUT WARRANTY OF ANY KIND, either express or implied. See the License for the specific language governing rights and limitations under the License.

❑ **tinymce 2002.4.3**

www.sourceforge.net/projects/tinymce
Original file by Yves Berquin.

This software is provided 'as-is', without any express or implied warranty. In no event will the authors be held liable for any damages arising from the use of this software.

Permission is granted to anyone to use this software for any purpose, including commercial applications, and to alter it and redistribute it freely, subject to the following restrictions:

1. The origin of this software must not be misrepresented; you must not claim that you wrote the original software. If you use this software in a product, an acknowledgment in the product documentation would be appreciated but is not required.
2. Altered source versions must be plainly marked as such, and must not be misrepresented as being the original software.
3. This notice may not be removed or altered from any source distribution.



❑ Tremor

<http://wiki.xiph.org/index.php/Tremor>

Copyright (c) 2002, Xiph.org Foundation

Redistribution and use in source and binary forms, with or without modification, are permitted provided that the following conditions are met:

1. Redistributions of source code must retain the above copyright notice, this list of conditions and the following disclaimer.
2. Redistributions in binary form must reproduce the above copyright notice, this list of conditions and the following disclaimer in the documentation and/or other materials provided with the distribution.
3. Neither the name of the Xiph.org Foundation nor the names of its contributors may be used to endorse or promote products derived from this software without specific prior written permission.

THIS SOFTWARE IS PROVIDED BY THE COPYRIGHT HOLDERS AND CONTRIBUTORS "AS IS" AND ANY EXPRESS OR IMPLIED WARRANTIES, INCLUDING, BUT NOT LIMITED TO, THE IMPLIED WARRANTIES OF MERCHANTABILITY AND FITNESS FOR A PARTICULAR PURPOSE ARE DISCLAIMED. IN NO EVENT SHALL THE FOUNDATION OR CONTRIBUTORS BE LIABLE FOR ANY DIRECT, INDIRECT, INCIDENTAL, SPECIAL, EXEMPLARY, OR CONSEQUENTIAL DAMAGES (INCLUDING, BUT NOT LIMITED TO, PROCUREMENT OF SUBSTITUTE GOODS OR SERVICES; LOSS OF USE, DATA, OR PROFITS; OR BUSINESS INTERRUPTION) HOWEVER CAUSED AND ON ANY THEORY OF LIABILITY, WHETHER IN CONTRACT, STRICT LIABILITY, OR TORT (INCLUDING NEGLIGENCE OR OTHERWISE) ARISING IN ANY WAY OUT OF THE USE OF THIS SOFTWARE, EVEN IF ADVISED OF THE POSSIBILITY OF SUCH DAMAGE.

❑ zlib

<http://www.zlib.net/>

zlib.h -- interface of the 'zlib' general purpose compression library version 1.2.3, July 18th, 2005

Copyright (C) 1995-2004 Jean-loup Gailly and Mark Adler

This software is provided 'as-is', without any express or implied warranty. In no event will the authors be held liable for any damages arising from the use of this software.

Permission is granted to anyone to use this software for any purpose, including commercial applications, and to alter it and redistribute it freely, subject to the following restrictions:

1. The origin of this software must not be misrepresented; you must not claim that you wrote the original software. If you use this software in a product, an acknowledgment in the product documentation would be appreciated but is not required.
2. Altered source versions must be plainly marked as such, and must not be misrepresented as being the original software.
3. This notice may not be removed or altered from any source distribution.

Jean-loup Gailly jloup@gzip.org, Mark Adler
madler@alumni.caltech.edu



DENON®
www.denon.com

D&M Holdings Inc.
3520 10356 11AD